

CLYMER® REPAIR MANUALS

YAMAHA

Yamaha Water Vehicles 1993-1996

WR500, SJ650, WR650,
WRA650, WRA650A,
WRB650, WRB650A, FX700,
SJ700, RA700, RA700A,
RA700B, WB700A, WRA700,
WRB700, WVT700, RA760,
WB760, RA1100, WVT100

Part No. W806



Yamaha Water Vehicles 1987-1992

WJ500, WRA650, WR500,
SJ650, WR650

Part No. W805



Yamaha Water Vehicles Four Stroke 2002-2009*

05-08 FX, 05-08 FX Cruiser
04-08 FX Cruiser High Output
04-08 FX High Output, 02-04 FX140
02-04 FX140 Cruiser, 05-09 VX
05-09 VX Cruiser, 05-09 VX Deluxe
05-09 VX Sport

Part No. W807

*Includes color wiring diagrams.
*Does not cover 1800 cc models. Does
not cover 2-stroke models.*

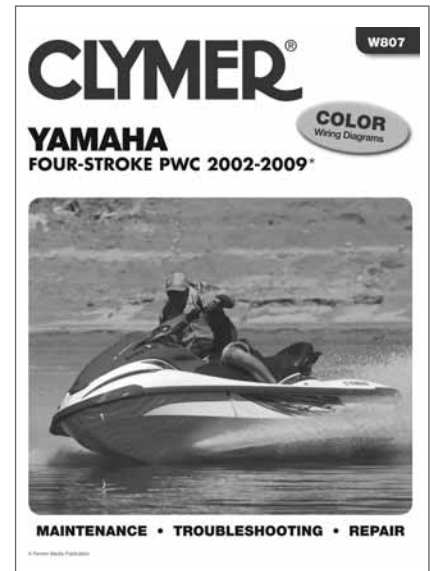

Kawasaki Jet Ski 1976-1991

JS300, JS550, JS300SX,
JS550SX, JS400, JF650X-2,
JS440, JS650SX, JF650TS,
JL650SC, JB650TS Jet Mate

Part No. W801



Kawasaki Jet Ski 1992-1994

JS440, JS550, JS550SX,
JB650 Jet Mate, JF650X-2,
JF650TS, JL650SC,
JS650SX, JH750SS,
JS750SX, JH750Xi,
JT750ST, JH750XIR

Part No. W802



SEA DOO

Sea Doo Water Vehicles 1988-1996

Standard GT, GTS, GTX,
SP, SPI, XP

Part No. W809-3



Sea Doo Water Vehicles 1997-2001

GS/GSI/GSX/GSX RFI/
GSX Ltd./GTI/GTS/GTX
GTX DI/GTX RFI/GTX Ltd.
HX/LRV/RX/RX DI
SP/SPX/XP Ltd.

Part No. W810



POLARIS

Polaris Water Vehicles 1993-1995

SL650, SL650STD,
SL750, SLT750

Part No. W819

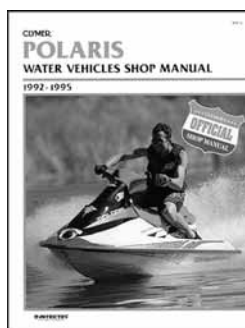

Polaris Water Vehicles 1996-1999

SL700, SLT700,
SL700 Deluxe, Hurricane,
SL780, SLT780, SL900,
SL1050, SLH, SLTH,
SLXN, SLTX

Part No. W820

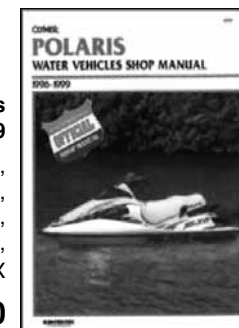

| | | | | | | | | | | | |
|-------------|----------------|----------------|---------|---------------------|------------|------------------|---------------------|------|-------------|-------------------------|----------|
| FOUR STROKE | INTAKE SYSTEMS | ENGINE/GASKETS | EXHAUST | DRIVE LINE HANDLING | ELECTRICAL | WATERLINE /BILGE | STEERING & CONTROLS | BODY | ACCESSORIES | SERVICE TOOLS /HARDWARE | CHEMICAL |
|-------------|----------------|----------------|---------|---------------------|------------|------------------|---------------------|------|-------------|-------------------------|----------|



**Mikuni
SUPER BN
CARBURETORS**

WATERCRAFT CARBURETOR
Overhead Injection

SUPER BN MANUAL

For the watercraft tuner working with Super BN series carburetors.

| Description | Part No. |
|---------------|----------|
| Mikuni Manual | 53-9999 |

FOUR STROKE
 INTAKE SYSTEMS
 ENGINE/GASKETS
 EXHAUST
 DRIVE LINE HANDLING
 ELECTRICAL
 WATERLINE /BILGE
 STEERING & CONTROLS
 BODY
 ACCESSORIES
 SERVICE TOOLS /HARDWARE
 CHEMICAL

METRIC STAINLESS STEEL HEX BOLT PACKS

10 Pcs Per Pack



| Size/mm | Part No. |
|---------|----------|
| 6 x 10 | 60-3010 |
| 6 x 12 | 60-3012 |
| 6 x 14 | 60-3014 |
| 6 x 16 | 60-3016 |
| 6 x 18 | 60-3018 |
| 6 x 20 | 60-3020 |
| 6 x 25 | 60-3025 |
| 6 x 30 | 60-3030 |
| 6 x 35 | 60-3035 |

| Size/mm | Part No. |
|---------|----------|
| 6 x 40 | 60-3040 |
| 6 x 45 | 60-3045 |
| 6 x 50 | 60-3050 |
| 6 x 60 | 60-3060 |
| 6 x 70 | 60-3070 |
| 6 x 80 | 60-3080 |
| 8 x 18 | 60-4018 |
| 8 x 20 | 60-4020 |

| Size/mm | Part No. |
|---------|----------|
| 8 x 25 | 60-4025 |
| 8 x 30 | 60-4030 |
| 8 x 35 | 60-4035 |
| 8 x 40 | 60-4040 |
| 8 x 50 | 60-4050 |
| 8 x 60 | 60-4060 |
| 8 x 80 | 60-4080 |
| 10 x 25 | 60-5025 |

METRIC STAINLESS STEEL SOCKET HEAD CUP BOLT PACKS

10 Pcs Per Pack



| Size/mm | Part No. |
|---------|----------|
| 4 x 30 | 61-1030 |
| 4 x 16 | 61-1016 |
| 5 x 10 | 61-2010 |
| 5 x 25 | 61-2025 |
| 6 x 10 | 61-3010 |
| 6 x 12 | 61-3012 |
| 6 x 14 | 61-3014 |

| Size/mm | Part No. |
|---------|----------|
| 6 x 16 | 61-3016 |
| 6 x 20 | 61-3020 |
| 6 x 25 | 61-3025 |
| 6 x 30 | 61-3030 |
| 6 x 35 | 61-3035 |
| 6 x 40 | 61-3040 |
| 6 x 50 | 61-3050 |

| Size/mm | Part No. |
|---------|----------|
| 6 x 60 | 61-3060 |
| 8 x 20 | 61-4020 |
| 8 x 25 | 61-4025 |
| 8 x 30 | 61-4030 |
| 8 x 50 | 61-4050 |
| 8 x 60 | 61-4060 |
| 10 x 25 | 61-5025 |

METRIC STAINLESS STEEL NUTS

10 Pcs Per Pack

| Size | Part No. |
|------|----------|
| 6mm | 63-0006 |
| 8mm | 63-0008 |



METRIC STAINLESS STUD PACKS

10 Pcs Per Pack

| Size/mm | Part No. |
|---------|----------|
| 8 X 30 | 62-4030 |



METRIC STAINLESS STEEL FLAT WASHERS

10 Pcs Per Pack

| Size | Part No. |
|------|----------|
| 6mm | 63-2006 |
| 8mm | 63-2008 |
| 10mm | 63-2010 |



METRIC STAINLESS STEEL SPRING WASHERS

10 Pcs Per Pack

| Size | Part No. |
|------|----------|
| 6mm | 63-4006 |
| 8mm | 63-4008 |
| 10mm | 63-4010 |



ZIP TIES



| Description | Color | Part No. |
|----------------|-------|----------|
| 3 3/4" x .090 | Black | 64-0050 |
| 7 1/4" x 1.190 | Black | 64-0051 |

(Sold in Packages of 100)

PLASTIC FITTINGS



| Plastic T Fitting | Part No. |
|-----------------------------|----------|
| 3/8" x 3/8" x 3/8" | 64-0025 |
| 1/2" x 1/2" x 1/2" | 64-0027 |
| Plastic Y Fitting | Part No. |
| 3/8" x 3/8" x 3/8" (white) | 64-0045 |
| 1/4" x 1/4" x 1/4" (white) | 64-0046 |
| 1/4" x 1/4" x 1/4" (black)* | 64-0047 |

*Reinforced with Crossbar

BRASS FITTINGS



| Straight Hose Barbed | Part No. |
|-----------------------|----------|
| 1/8" Thread 1/4" Hose | 64-0001 |
| 1/8" Thread 3/8" Hose | 64-0003 |
| 1/4" Thread 1/2" Hose | 64-0005 |



| Barb Connector | Part No. |
|-------------------------------|----------|
| 1/4" I.D. Hose-1/4" I.D. Hose | 64-0057 |
| 3/8" I.D. Hose-3/8" I.D. Hose | 64-0058 |
| 1/2" I.D. Hose-1/2" I.D. Hose | 64-0059 |



| Brass Push in Nipple | Part No. |
|----------------------|----------|
| 1/8" Straight | 53-9936 |
| 1/4" Straight | 53-9937 |



| 90 Degree | Part No. |
|----------------------------|----------|
| 1/8" Pipe thread 3/8" Hose | 64-0007 |
| 1/4" Pipe thread 1/2" Hose | 64-0009 |
| 1/8" Pipe thread 1/4" Hose | 64-0010 |
| 1/2" Pipe thread 1/2" Hose | 64-0008 |



| Garden Hose Adapter | Part No. |
|---------------------|----------|
| 3/8" | 64-0012 |



| Press-in 90 Degree Fuel Inlet | Part No. |
|-------------------------------|-----------|
| 1/4" 90 Degree | DF44-2/70 |



| 45 Degree | Part No. |
|----------------------------|----------|
| 1/8" Pipe thread 1/4" Hose | 64-0065 |
| 1/8" Pipe thread 3/8" Hose | 64-0066 |
| 1/4" Pipe thread 1/2" Hose | 64-0067 |



| Brass Fitting | Part No. |
|-----------------------------|----------|
| 1/8" Pipe threaded junction | 64-0011 |
| 1/8" to 1/4" Adapter | 64-0013 |
| 9mm Yamaha Flush Adapter | 64-0004 |



| T-Fitting | Part No. |
|-----------------------------------|----------|
| Primer Fitting 1/8" x 1/8" x 1/8" | 64-0015 |
| Primer 1/4" x 1/4" x 1/8" | 64-0017 |
| Fuel Line 1/4" x 1/4" x 1/4" | 64-0019 |



| Brass Threaded Plug | Part No. |
|---------------------|----------|
| 1/8" Threaded Plug | 64-0016 |
| 1/4" Threaded Plug | 64-0018 |



2010 WORLD FINALS • LAKE HAVASU, AZ
CHRIS MCCLUGAGE • MACC RACING
PHOTO COURTESY OF JIN OMURA

| | | | | | | | | | | |
|-------------|----------------|----------------|---------|---------------------|------------|------------------|---------------------|------|-------------------------------------|----------|
| FOUR STROKE | INTAKE SYSTEMS | ENGINE/GASKETS | EXHAUST | DRIVE LINE HANDLING | ELECTRICAL | WATERLINE /BILGE | STEERING & CONTROLS | BODY | ACCESSORIES SERVICE TOOLS /HARDWARE | CHEMICAL |
|-------------|----------------|----------------|---------|---------------------|------------|------------------|---------------------|------|-------------------------------------|----------|

FOUR
STROKEINTAKE
SYSTEMSENGINE/
GASKETS

EXHAUST

DRIVE LINE
HANDLING

ELECTRICAL

WATERLINE
/BILGESTEERING
& CONTROLS

BODY

SERVICE TOOLS
ACCESSORIES

/HARDWARE

CHEMICAL



STAINLESS STEEL HOSE CLAMPS

| Clamps | Maximum Size | Minimum Size | Part No. |
|----------------|--------------|--------------|----------|
| #5 (Waterline) | 1 1/16" | 1/4" | 64-0030 |
| #36 | 2 3/4" | 1 13/16" | 64-0032 |
| #48 | 3 1/2" | 2 9/16" | 64-0031 |
| #60 | 4 1/4" | 3 5/16" | 64-0033 |
| #72 | 5" | 4 1/16" | 64-0034 |
| #80 | 5 1/2" | 4 9/16" | 64-0035 |



T-BOLT CLAMPS

| Size | Width | Part No. |
|--------|-------|----------|
| 3" | 3/4" | 64-0080 |
| 3-1/4" | 3/4" | 64-0081 |
| 4-1/2" | 3/4" | 64-0082 |
| 5" | 3/4" | 64-0084 |
| 5-1/4" | 3/4" | 64-0085 |
| 5-1/2" | 3/4" | 64-0086 |



HOSE SHEARS

Scissor-action cutter for hose.

| Description | Part No. |
|-------------|----------|
| Hose Shears | 59-4020 |



FUEL LINE

Fuel line is made from a thick walled polyurethane tubing. Sold per foot. or 25 feet/pk

| Description | Part No. |
|------------------------------------|------------|
| Blue (1/4") per foot | 53-9970 |
| Blue (1/4") 25 feet package | 53-9970-25 |
| Primer Line (1/8") per foot | 53-9980 |
| Primer Line (1/8") 25 feet package | 53-9980-25 |

Fast, Easy, Strong and Secure Installation



SQUEEZE ON STAINLESS STEEL LOW PROFILE CLAMPS

Oetiker Stepless Ear Clamps, due to the reinforcing 'dimple' in the ear, hold against pressure and vibration or hose shrinkage due to temperature changes. A built-in spring action permits the clamp to "breathe" without loosening, the need to retighten is eliminated. Once installed, any tampering is easily visible, making this an excellent clamp for service or security applications.

Fast & Easy Removal

| Description | Clamp Size | Part No. |
|---------------------------------------|------------|----------|
| Pincer Tool | - | 59-4015 |
| Clamp for 1/4" Hose (10 pcs/pk) | 9/16 | 59-4016 |
| Clamp for 3/8" Water Line (10 pcs/pk) | 11/16 | 59-4017 |
| Clamp for 1/2" Water Line (10 pcs/pk) | 13/16 | 59-4018 |

| 100 Clamp Packs | Clamp Size | Part No. |
|--|------------|-------------|
| Clamp for 1/4" Hose (100 pcs/pk) | 9/16 | 59-4016-100 |
| Clamp for 3/8" Water Line (100 pcs/pk) | 11/16 | 59-4017-100 |
| Clamp for 1/2" Water Line (100 pcs/pk) | 13/16 | 59-4018-100 |

FLEX-TECH WATER LINE HOSE



Flex-Tech multi purpose hose is more flexible and bendable for those complicated water routing requirements. This waterline is highly recommended for Factory

and TBM Dry Pipe installations. Waterline is sold per foot.

| Description | Part No. |
|--|----------|
| 3/8" Flex-Tech Light Blue Waterline Hose | 56-8010 |

WATER LINE HOSE



Goodyear hose has been replacing rubber hose or metal tubing designs. Goodyear hose and tubing offers customers a

number of benefits, including flexibility, durability, abrasion resistance, lighter weight materials, superior chemical resistance, high pressure capability, and extended product performance. Waterline is sold per foot.

| Description | Part No. |
|-------------------|----------|
| 3/8" Blue | 56-8000 |
| 1/2" Blue | 56-8004 |
| 3/8" Clear Vinyl* | 56-8007 |

*Clear vinyl hose is not manufactured by Goodyear.

500 foot reel 3/8" blue hose available and
400 foot reel 1/2" blue hose available

Call for special pricing on reel purchases.

SEA DOO REPAIR TOOLS

These tools are built to the the OEM specialty tool specifications and have been built using high quality materials.

Make your work day and the repairs you perform for your customers faster and more efficient with the right tool for the job!



Drive Shaft / Floating Ring
Part No. 950-100
O.E. No. 529-035-841
Fits: GTX 4 Tec Models



Drive Shaft / Floating Ring
Part No. 950-102
O.E. No. 529-035-987
Fits: Super Charged 4-Tecs



Drive Shaft Adaptor
Part No. 950-115
O.E. No. 529-035-892
Fits: GTX 4 Tec

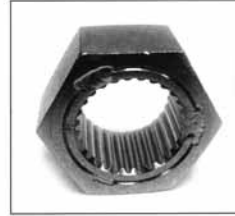

Drive Shaft Adaptor
Part No. 950-120
O.E. No. 529-035-985
Fits: RXP 4 Tec



Torx Adapter For All Super Charged 4-Tecs
Part No. 950-185
O.E. No. 529-035-938
Fits: 4-Tec Supercharged



Insert Alignment Tool Adapter
Part No. 950-145
O.E. No. 529-035-590
Fits: XP & DI Models



Alignment Adaptor
Part No. 950-150
O.E. No. 529-035-719
Fits: GTX 4-Tec Models



Super Charger Retaining Key
Part No. 950-110
O.E. No. 529-035-949
All 4 Tec's with Super Chargers



Crankshaft Locking Tool
Part No. 950-125
O.E. No. 529-035-821
Fits: All 4 Tec's



4-Pin Socket
Part No. 950-195
O.E. No. 529-035-948
Fits: 4-Tec Supercharged



Pressure Cap
Part No. 950-105
O.E. No. 529-035-843
Fits: GTX 4 Tec



Steering Cable Nut Removal Tool
Part No. 950-130
O.E. No. 295-000-145
Fits: All Models



Support Plate 4-TEC Supercharged Engines
Part No. 950-190
O.E. No. 529-035-947
Fits: 4-Tec Supercharged



Alignment Support Plate kit
Part No. 950-135
O.E. No. 529-035-506
Fits: All Models



Camshaft Locking tool
Part No. 950-180
O.E. No. 529-035-839
Fits: 4-Tec Engines

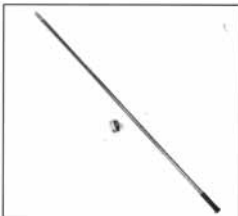

Alignment Shaft
Part No. 950-140
O.E. No. 295-000-141
Fits: All Models



Drive Shaft Holder
Part No. 950-155
O.E. No. 529-035-986
Fits: GTX 4-Tec & RXP 4-Tec Models



Seal & Bearing Pusher
Part No. 950-165
O.E. No. 529-035-955
Fits: GTX 4-Tec Models



Shaft Pusher
Part No. 950-170
O.E. No. 529-035-819
Fits: GTX 4-Tec Models



Ring Gear Blocking Tool
Part No. 950-175
O.E. No. 529-035-946
Fits: 787 RFI Engines & 947 DI Engines



Ball Bearing Support Pusher
Part No. 950-200
O.E. No. 529-035-950
Fits: 4-Tec Supercharged



Ring Gear Blocking Tool
Part No. 950-172
O.E. No. 529-035-846
Fits: 529035846

| | | | | | | | | | | |
|-------------|----------------|----------------|---------|---------------------|------------|------------------|---------------------|------|-------------------------------------|----------|
| FOUR STROKE | INTAKE SYSTEMS | ENGINE/GASKETS | EXHAUST | DRIVE LINE HANDLING | ELECTRICAL | WATERLINE /BILGE | STEERING & CONTROLS | BODY | ACCESSORIES SERVICE TOOLS /HARDWARE | CHEMICAL |
|-------------|----------------|----------------|---------|---------------------|------------|------------------|---------------------|------|-------------------------------------|----------|

Hot Products is proud to offer a complete line of Service Tools and Hardware for all your service and Repair needs.



FOR SEA DOO ENGINE



VALVE COMPRESSION TOOL SD 4-TEC

Our overhead Valve Compression Tool allows easy removal of valve springs and keepers without removing cylinder head. Includes compression adapter to pressurize cylinder keeping valves in place during removal of stock springs and keepers.

| Description | Part No. |
|-----------------------------------|-------------|
| Tool, Valve Compression, SD 4-TEC | RS19050-VCT |

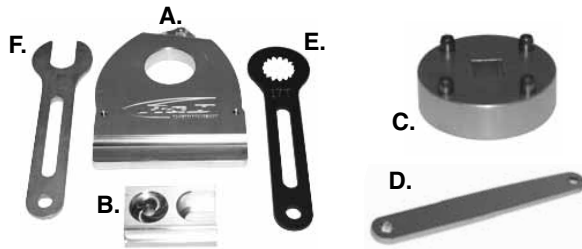

R&D SEA DOO SUPERCHARGER REBUILD TOOL KIT

R&D has designed a custom tool kit that is essential in the rebuilding process of the Sea Doo Supercharger. All tools are specific in application and are CNC machined to ensure a precision job.

| Description | Part No. |
|---|-----------|
| A. Supercharger Holder Tool | 613-96005 |
| B. Bearing Puller/Installer Tool | 613-96006 |
| C. 4-Pin Socket | 613-96007 |
| D. Seal/Bearing Retainer Torx Wrench | 613-96008 |
| E. 215HP 16 Tooth Drive Gear Tool | 613-96016 |
| E. 185HP 17 Tooth Drive Gear Tool | 613-96017 |
| F. 185HP/215HP Clutch Drive /Lock Washer Tool | 613-96018 |



RIVA SEADOO SUPERCHARGER SHAFT HOLDER TOOL

Our SeaDoo Supercharger Shaft Holder Tool makes servicing your supercharger a snap. Ergonomically designed billet handle allows a sure, firm grip without fatiguing your hand. Working ends are made from heat treated tool-grade steel to resist wear and are oversized to prevent flexing. A must for every mechanic's tool box!

| Description | Part No. |
|----------------------------------|----------------|
| RIVA SeaDoo SC Shaft Holder Tool | RS1750-ISH-949 |



TORX® SOCKET SET FOR SEA DOO

Special Star Sockets for Sea Doo 4-Tec & DI engine bolts are made from heat-treated vanadium steel and black oxide coated for durability. Sockets are kept in a convenient vinyl holder.

are kept in a convenient vinyl holder.

- Four 3/8" Drive Sockets (T10, T12, T14, T16)
- Three 1/4" Drive Sockets (T6, T7, T8)

| Description | Part No. |
|-----------------|----------|
| Torx Socket Set | LS26750 |

FOR YAMAHA 1.8L ENGINE

R&D SPECIALTY SUPERCHARGER TOOLS FOR YAMAHA 1.8L ENGINE

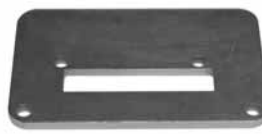

G.

H.

R&D has designed a custom tool kit that is essential in the rebuilding process of the Yamaha Supercharger. All tools are specific in application and are CNC machined to ensure a precision job.

| Description | Part No. |
|---|-----------|
| G. Supercharger Housing Holder Bracket Tool | 612-92010 |
| H. Shaft/Gear Holding Tool | 612-92011 |



R&D SUPERCHARGER CLUTCH REMOVAL TOOL FOR YAMAHA 1.8L ENGINE

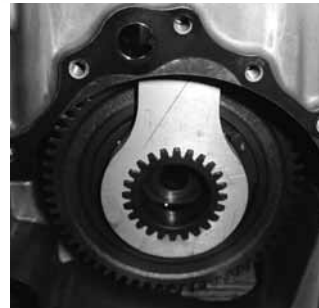

This R&D tool enables the clutch to be changed in a matter of only minutes. With the supercharger and front engine cover removed the tool drops down through the case and secures the drive gear at the front of the crankshaft from rotating when the

clutch is removed and installed. This is a "must have" tool that will save massive amounts of time for any mechanic.

| Description | Part No. |
|--------------------------------------|-----------|
| R&D Supercharger Clutch Removal Tool | 612-92012 |



FZR VALVE SPRING COMPRESSION TOOL KIT

The R&D Valve Spring Compression Tool Kit allows easy removal of the intake or exhaust valve springs and keepers without removing the cylinder

head. R&D recommends using the compression adapter from a compression gauge kit to pressurize cylinder keeping valves in place during removal of springs and keepers.

| Description | Part No. |
|---------------------------------------|-----------|
| FZR Valve Spring Compression Tool Kit | 612-92013 |



R&D VALVE STEM CONCENTRICITY GAUGE

The R&D Valve Stem Concentricity Gauge is a testing tool to check the roundness and trueness of valves. Small valves can distort or bend from heat produced in high performance supercharged or turbo charged engines. To achieve a perfect seal on the seat the valve

needs to be concentric and true in every dimension. Gauge is fully adjustable to accommodate a variety of valve sizes and features a rigid, positive stop that can be set once and the trueness for an entire set of valves can be measured. Kit comes complete with dial indicator accurate to .001". This is a must have tool for any engine builder to get the most out of your high performance 4 stroke engine.

| Description | Part No. |
|------------------------------------|-----------|
| R&D Valve Stem Concentricity Gauge | 612-80010 |

FOR YAMAHA 1.8L ENGINE



RIVA ENGINE VALVE SEAL TOOL

This handy tool provides easy removal and installation of valve stem seals on Yamaha 1.8L engines. Allows seal installation during fitting of valve train upgrade kit without removing cylinder head.

- Prevents seal distortion & gouging.
- Precision machined from 6061 aluminum & anodized.
- Knurled handle for positive grip.

| Description | Part No. |
|--|-------------|
| Valve Seal Tool for Yamaha 1.8L Engine | RY19040-VST |



TORQUE ANGLE METER

For All Torque-to-Yield Fastener Applications. Commonly used for tightening head bolts & other bolts where a torque angle is required. Use with 1/2" drive.

| Description | Part No. |
|--------------------|----------|
| Torque Angle Meter | LS28100 |



RIVA VALVE COMPRESSION TOOL

Riva's overhead Valve Compression Tool allows easy removal of valve springs and keepers without removing cylinder head. Includes compression adapter to pressurize cylinder keeping valves in place during removal of stock springs and keepers. Fits both Yamaha 1.8L & Kawasaki 1.5L 4-stroke engines.

| Description | Part No. |
|--|-------------|
| RIVA Valve Compression Tool Fits Yamaha 1.8L & Kawasaki 1.5L 4-stroke | RY19040-VCT |

FOR KAWASAKI ENGINE



R&D ULTRA 250/260X SUPERCHARGER WHEEL PULLER TOOL

The R&D wheel puller tool makes it fast and easy to remove a supercharger wheel without the removal of the intercooler system or the water muffler assembly. The R&D Supercharger drive wheel puller will save at least an hour on a pulley removal and replacement. A must have tool.

| Description | Part No. |
|---|-----------|
| R&D Ultra 250/260X SC Wheel Puller Tool | 611-26004 |



R&D ULTRA 250/260X DRIVER WHEEL HOLDER TOOL

The R&D Holding Tool makes it fast and easy to remove and re-install a supercharger wheel without damaging or breaking the wheel hub. Use the holding tool to properly torque the drive bolts and main spline drive bolt. A must have tool.

| Description | Part No. |
|---|-----------|
| Ultra 250/260X Driver Wheel Holder Tool | 611-26003 |



2010 WORLD FINALS • LAKE HAVASU, AZ
CHRIS McCLUGAGE • MACC RACING
PHOTO COURTESY OF JIN OMURA

| | | | | | | | | | | |
|-------------|----------------|----------------|---------|---------------------|------------|------------------|---------------------|------|-------------------------------------|----------|
| FOUR STROKE | INTAKE SYSTEMS | ENGINE/GASKETS | EXHAUST | DRIVE LINE HANDLING | ELECTRICAL | WATERLINE /BILGE | STEERING & CONTROLS | BODY | ACCESSORIES SERVICE TOOLS /HARDWARE | CHEMICAL |
|-------------|----------------|----------------|---------|---------------------|------------|------------------|---------------------|------|-------------------------------------|----------|



CARB SCREW ADJUSTING TOOL

Angled head for the hard-to-reach carb adjustment screws

| Description | Part No. |
|---------------------------|----------|
| Carb Screw Adjusting Tool | 53-9994 |



90 DEGREE 1/4" HEX DRIVER

Precision made of high-grade aluminum & stainless steel. Designed for hard-to-reach pilot screw. Gear driven 1/4" hex. Includes 1/4" hex bits, straight slot, Phillips, D-shaped pilot screw bit, 6mm hex jet bit and 1/4"-hex-to-1/4" drive bit.

| Description | Part No. |
|---------------------------|----------|
| 90 Degree 1/4" Hex Driver | 08-0229 |

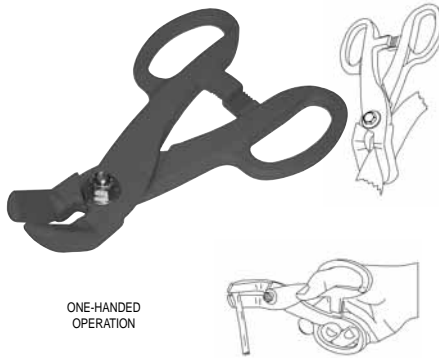

ONE-HANDED OPERATION

HOSE PINCHER

Clamps and holds hoses up to 3/4" inside diameter. Angled jaws close to create a complete seal every time. Jaws are offset for hard-to-reach areas. The handles lock firmly to hold the jaws in closed position.

| Description | Part No. |
|---------------|----------|
| Hose Pinchers | LS23000 |

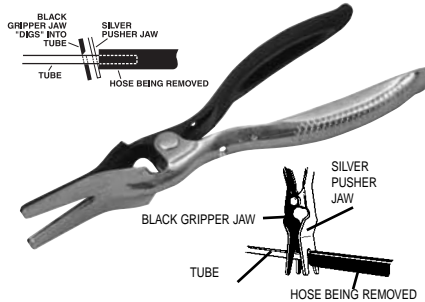

BLACK GRIPPER JAW "DIGS" INTO TUBE
SILVER PUSHER JAW
TUBE
HOSE BEING REMOVED

SILVER PUSHER JAW
BLACK GRIPPER JAW
TUBE
HOSE BEING REMOVED

HOSE REMOVAL PLIERS

For easy removal of 5/32" to 1/2" (4mm to 14mm) hoses. Engage the tube (line) with the black jaw. This sharpened jaw actually "digs" into the tube to grip it! Squeeze, and the hose is easily pushed off by the silver jaw.

| Description | Part No. |
|---------------------|----------|
| Hose Removal Pliers | LS47900 |

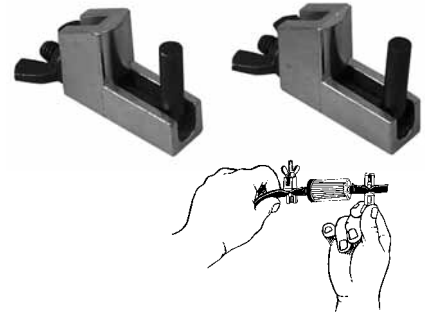

HOSE PINCHERS

Quick, easy way to pinch off fuel lines, etc. without damaging the line. Sold two per set.

| Description | Part No. |
|---------------|----------|
| Hose Pinchers | LS22850 |



MIKUNI TOOL KIT

This handy little kit contains all the tools necessary to make jetting change, perform normal maintenance as well as disassemble and rebuild any Mikuni carburetor

| Description | Part No. |
|-----------------|----------|
| Mikuni Tool Kit | 53-9989 |



ROTARY VALVE TIMING WHEEL

| Description | Part No. |
|---------------------------|----------|
| Rotary Valve Timing Wheel | 012-170 |



MIKUNI POP-OFF GAUGE

For Accurate adjustment of pop off pressure levels for fine tuning requirements.

| Description | Part No. |
|-----------------------|-------------|
| Mikuni 30 Lbs. Gauge | 53-9996 |
| Mikuni 60 Lbs. Gauge | 53-9996-60 |
| Mikuni 100 Lbs. Gauge | 53-9996-100 |



ENGINE SERVICE TOOLS

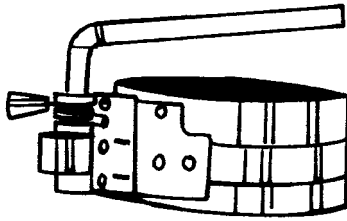

QUICK RELEASE RING COMPRESSOR

Ring Compressor makes it easy to remove ring from piston. Range is from 2-1/8" – 5" (54mm–127mm).

| Description | Part No. |
|-------------------------------|----------|
| Quick Release Ring Compressor | LS19000 |

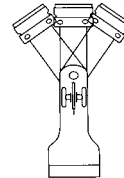

Locks in 3 Different Positions.

FOLD-UP SCRAPER

The fold-up scraper features three arm positions and a slanted blade for proper scraping. Great for removing decals, etc.

| Description | Part No. |
|-----------------|----------|
| Fold-up Scraper | LS52400 |

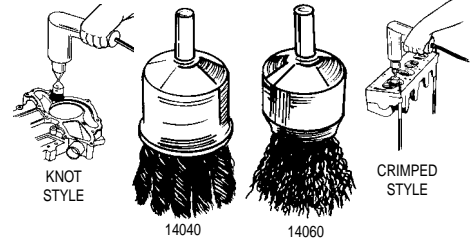

1" WIRE END BRUSHES

Made with .020" industrial heat-tempered wire. Use with portable electric and air tools. 20,000rpm maximum safe speed.

| Description | Part No. |
|---------------------------|----------|
| 1" Knot Wire End Brush | LS14040 |
| 1" Crimped Wire End Brush | LS14060 |

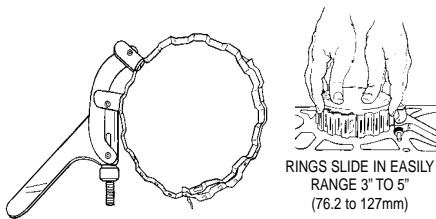

RINGS SLIDE IN EASILY RANGE 3" TO 5" (76.2 to 127mm)

WRINKLE BAND RING COMPRESSOR

Wrinkle band cuts friction in half. Rings slide in easily 3" – 5" (76.2mm – 127mm).

| Description | Part No. |
|------------------------------|----------|
| Wrinkle Band Ring Compressor | LS21700 |

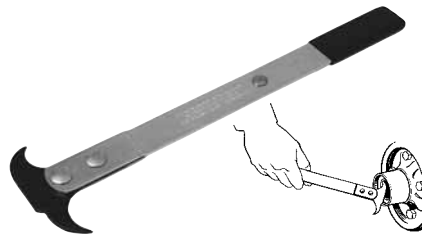

SEAL PULLER

Simply insert the tip of the tool behind the oil or grease seal, press and pull. Leverage works for you. Two size tips reach in and fit nearly all seal applications.

| Description | Part No. |
|-------------|----------|
| Seal Puller | LS56750 |

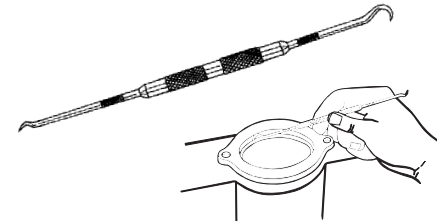

"O" RING AND SEAL PICK

Quickly removes and installs "O" rings and seals. Tips are hardened to stay sharp.

| Description | Part No. |
|------------------------|----------|
| "O" Ring and Seal Pick | LS31840 |

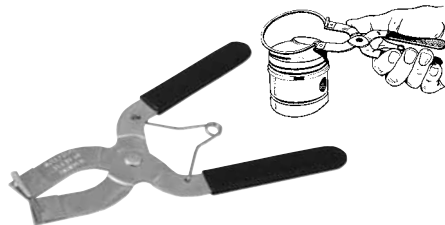

PISTON RING INSTALLER

| Description | Part No. |
|-----------------------|----------|
| Piston Ring Installer | LS33500 |



PISTON PIN PULLER

Universal piston pin puller easily removes all sizes of piston pins without any damage to the piston.

| Description | Part No. |
|-------------------|----------|
| Piston Pin Puller | 59-0252 |

| CONVERSION TABLE | |
|---------------------------------|----------------------------|
| Unit | Conversion |
| Linear Measure | |
| centimeter (cm.) | 0.3937 inch |
| meter (m.) | 3.2808 feet / 1.0936 yards |
| kilometer (km.) | 0.6214 mile |
| inch (in.) | 2.54 centimeters |
| foot (ft.) = 12 inches | 30.48 centimeters |
| yard (yd.) = 3 feet | 0.914 centimeters |
| rod (rd.) = 5.5. yards | 5.0292 meters |
| chain (ch.) = 4 rods | 20.117 meters |
| furlong (fur.) = 10 chains | 201.17 meters |
| mile (m., mi.) = 8 furlongs | 1.6093 kilometers |
| league (l.) = 3 miles | 4.8279 kilometers |
| Aviordupois Weight | |
| Gram (g.) | 0.0353 oz. avdp. |
| kilogram (kg.) = 1,00 grams | 2.2046 lb. avdp |
| metric ton (M.T.) | 1.1023 short tons |
| | 0.9842 long ton |
| grain (gr.) | 0.0648 gram |
| dram (dr. avdp.) = 27.34 grains | 1.7718 grams |
| ounce (oz.avdp.) = 16 drams | 28.3495 grams |
| pound (lb. avpd) = 16 ounces | 0.4536 kilogram |
| hundredweight (cwt.) | |
| (US) = 100 pounds | 45.3592 kilograms |
| (UK) = 112 pounds | 50.8024 kilograms |
| ton (t., tn.) | |
| (US) = short ton | |
| =2,000 pounds | 0.907 metric ton |
| (UK) = short ton | |
| =2,240 pounds | 1.106 metric ton |



COMPRESSION TESTER

Contains hoses for 10, 12 & 14mm spark plug applications. Features a quick disconnect with a pressure release valve and a 300lbs. Gauge. Packed in a convenient carry box. Made in USA.

| Description | Part No. |
|--------------------|----------|
| Compression Tester | 08-0188 |

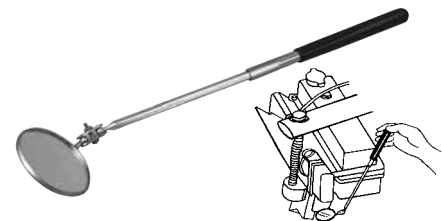

TELESCOPING MIRROR

Enables you to see around corner. 2-1/4" diameter mirror swivels to any position. Length extends from 10" to 14".

| Description | Part No. |
|--------------------|----------|
| Telescoping Mirror | LS32050 |

FOUR STROKE
INTAKE SYSTEMS
ENGINE/GASKETS
EXHAUST
DRIVE LINE HANDLING
ELECTRICAL
WATERLINE /BLIGE
STEERING & CONTROLS
BODY
ACCESSORIES SERVICE TOOLS /HARDWARE
CHEMICAL



PRO-CRIMP TOOL

To do a job right, it is important to have the right tools. If you custom build a lot of plug wires, the Pro-Crimp is the right tool for you! The Pro-Crimp features a hardened steel frame, molded hand grips and built-in ratchet action that is also adjustable. The tool is supplied with jaws to fit MSD's Super Conductor Spark Plug wires and can be removed to use additional jaws (sold separately) for crimping common wiring terminals.

| Description | Part No. |
|-----------------------|----------|
| MSD Pro Crimp Tool | 3505 |
| Spark Plug Dies | 3508 |
| Amp Pins | 3506 |
| Amp Lug Dies | 3507 |
| Weathertight Dies | 3509 |
| Deutsch Terminal Dies | 3510 |



TERMINAL DETENT TOOL

The hollow barrel allows you to depress the tab on the terminal end and to remove the wire from the connector without damaging its ends.

| Description | Part No. |
|----------------------|----------|
| Terminal Detent Tool | 59-0254 |

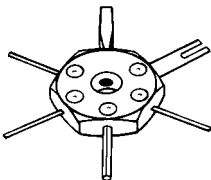

TERMINAL REMOVAL TOOL

Includes six different shaped blades.

| Description | Part No. |
|-----------------------|----------|
| Terminal Removal Tool | LS14900 |



PERMA-SEAL CONNECTOR KIT

| Description | Part No. |
|------------------------------|----------|
| MSD Perma-Seal Connector Kit | 4377 |



TIMING LIGHTS

MSD offers a heavy duty top quality timing light. This timing light is supplied in a heavy duty metal housing and features a high output Linear Xenon strobe with a focused fresnel lens that produces a light that's bright enough to use outdoors. It is equipped with a 6 foot lead and uses a metal inductive pickup that clamps to the spark plug wire.

| Description | Part No. |
|--------------|----------|
| Timing Light | 8990 |



TIMING DEGREE WHEEL

Set total loss timing with no guess work. Check crank shaft timing to exact degree. A must for porting and port timing.

| Description | Part No. |
|---------------------|----------|
| Timing Degree Wheel | 08-0092 |



FLYWHEEL PULLER

| Description | Part No. |
|------------------------------|----------|
| Sea Doo 800/951 38mm x 1.5 | MP#42 |
| Kawasaki 900/1100 35mm x 1.5 | DS#29 |

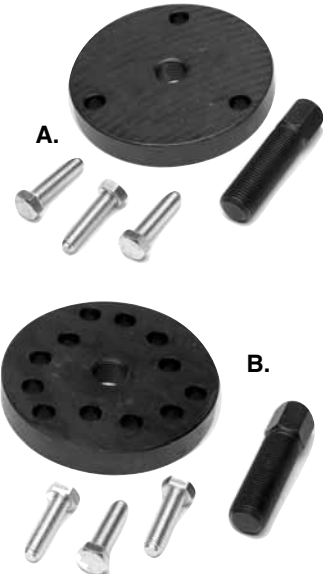

MAGNETO FLYWHEEL PULLER

| Sea Doo | Part No. |
|------------------------------|----------|
| A. 580/650/720 | DS#34 |
| 3 Hole Disc 8mm Bolts | |

| Polaris | Part No. |
|---|----------|
| B. Polaris ALL & Universal | DS#37 |
| Universal 12 Hole Disc 8mm Bolts | |

| YAMAHA | Part No. |
|---|----------|
| B. 500/650/Pre 94 701 | DS#37 |
| Universal 12 Hole Disc 8mm Bolts | |
| B. 701/760/800/1100/1200 | DS#37 |
| Universal 12 Hole Disc 8mm Bolts | |

| KAWASAKI | Part No. |
|---|----------|
| B. 300/440/550/650 | DS#37 |
| Universal 12 Hole Disc 8mm Bolts | |



| | |
|------------------------|-------|
| C. 750/800 | MP#18 |
| Special | |
| 18mm x 1.5 | |
| Right Hand Bolt | |

MAINTAINER MODEL #CU2602

Total Amps: 0.5
Battery System: 12Volt



| Description | Part No. |
|--------------------|----------|
| Battery Maintainer | CU2602 |

CHARGER MODEL #CU2606A

Total Amps: 6
Battery System: 12Volt



| Description | Part No. |
|--------------------------|----------|
| Portable Battery Charger | CU2606A |

CHARGER MODEL #CU2612A

Total Amps: 10
Battery System: 12Volt



| Description | Part No. |
|--------------------------|----------|
| Portable Battery Charger | CU2612A |



JUMPER CABLES

8 feet long heavy duty 8 gauge copper jumper cables are big on charging power, yet stow conveniently in the 9 x 9 inch nylon bag.

| Description | Part No. |
|---------------|----------|
| Jumper Cables | 59-0530 |



SPARK PLUG TOOLS

| Description | Part No. |
|---------------------|----------|
| Ratchet Plug Wrench | 59-0539 |



SPARK PLUG WIRE TESTER

Now you can check spark plug wires without piercing the wires. Light flashes indicating sound wire.

| Description | Part No. |
|------------------------|----------|
| Spark Plug Wire Tester | LS26900 |



IGNITION SYSTEM SPARK TESTER

This ignition system tester checks the integrity and strength of your system by gauging your systems spark.

| Description | Part No. |
|------------------------------|----------|
| Ignition System Spark Tester | 59-0253 |

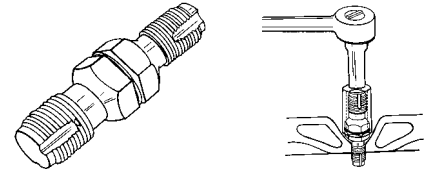

SPARK PLUG HOLE THREAD CHASER

Cleans threads in spark plug hole. Use with 13/16" spark plug socket. Double-ended for both 14mm and 18mm threads.

| Description | Part No. |
|-------------------------------|----------|
| Spark Plug Hole Thread Chaser | LS20200 |

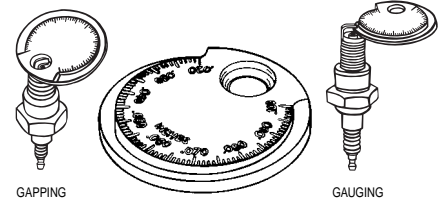

STANDARD/HIGH ENERGY SPARK PLUG GAUGE & GAPPER

Gauge and gap all types of spark plugs from .020" to .110 (.50mm to 2.53mm).

| Description | Part No. |
|-----------------------------|----------|
| Spark Plug Gauge and Gapper | LS67870 |



SPARK PLUG HOLDERS

Spark Plug Holder protects the electrode, maintaining the proper gap.

| Description | Part No. |
|---------------------------|----------|
| 2 per Blister Pack | SPH-2 |
| 40 per Countertop Display | SPH-40 |



FOUR STROKE
INTAKE SYSTEMS
ENGINE/GASKETS
EXHAUST
DRIVE LINE HANDLING
ELECTRICAL
WATERLINE /BILGE
STEERING & CONTROLS
BODY
ACCESSORIES SERVICE TOOLS /HARDWARE
CHEMICAL

FOUR STROKE
INTAKE SYSTEMS
ENGINE/GASKETS
EXHAUST
DRIVE LINE HANDLING
ELECTRICAL
WATERLINE /BILGE
STEERING & CONTROLS
BODY
SERVICE TOOLS ACCESSORIES /HARDWARE
CHEMICAL



SUPER OUT EXTRACTOR SET

A super strong extractor set made of a special hardened, shock-resistant tool steel.

Works on both left and right hand threads. Super Outs cut their way straight into bolts, eliminating wadding or further tightening of frozen bolts and screws. Five extractor sizes extract 1/4" to 1/2" and larger bolts and screws.

| Description | Part No. |
|-------------------------|----------|
| Super Out Extractor Set | LS62900 |



3/8" HAND IMPACT TOOL SET

Loosens Rusted, Frozen Nuts, Bolts and Screws. Unique design delivers over 200 ft. lbs. of Shock Torque. Can be reversed to tighten. Can also be used with impact sockets!



| Part No. | Impact Set Includes: |
|----------|------------------------|
| 29200 | 3/8" Impact Tool |
| 29000 | 3/8" Bit Holder |
| 29520 | #1 Phillips Bit |
| 29630 | #2 Phillips Bit |
| 30180 | #3 Phillips Bit |
| 29550 | #4 Phillips Bit |
| 30190 | 3/8" Straight Slot Bit |

| Description | Part No. |
|---------------------------|----------|
| 3/8" Hand Impact Tool Set | LS29200 |

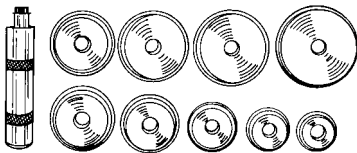

SET INCLUDES ONE OF EACH OF THE FOLLOWING DRIVERS:

| DRIVER PART NO. | SIZE |
|-----------------|--------|
| 12610 | 1.565" |
| 12620 | 1.750" |
| 12630 | 1.965" |
| 12640 | 2.325" |
| 12710 | 2.470" |
| 12650 | 2.555" |
| 12690 | 2.630" |
| 12700 | 2.995" |
| 12970 | 3.180" |

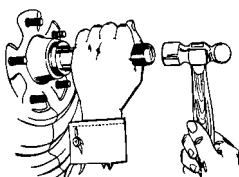

BEARING RACE AND SEAL DRIVER—MASTER SET

Make it easier to insert bearing race and seals without damage to race. This master set includes nine drivers to fit most standard bearings.

| Description | Part No. |
|-----------------------------|----------|
| Bearing Race and Seal Drive | LS12980 |
| Handle Mini pouched | LS12660 |



IMPELLER HOLDER TOOL

Holds spline of drive shaft for removal of impeller.

| Sea Doo | Part No. |
|---|----------|
| A. 580/650/720/800/951 All 18mm spline | DS#23 |
| Polaris | Part No. |
| B. Polaris ALL & long reach univ. 20mm spline | DS#38 |



IMPELLER HOLDER TOOL

| Sea Doo | Part No. |
|-----------------------|----------|
| C. GTX 4Tec SC (22mm) | DS#70 |
| D. RXP/RXT (27mm) | DS#71 |



SOLAS IMPELLER HOLDER TOOL

| Sea Doo | Part No. |
|----------------|-----------|
| RXP/RXT (27mm) | WR012-SRX |



IMPELLER HOLDER TOOL FOR KAWASAKI

| Kawasaki | Part No. |
|---|----------|
| E. 440/550-89 16mm spline | DS#24 |
| F. 650/750/900/1100 & Ultra 250/260 18mm spline | DS#23 |



IMPELLER SHAFT HOLDER TOOL FOR YAMAHA

| Yamaha | Part No. |
|--------------------------------------|----------|
| G. WR500, WJ650LX 16mm spline | DS#27 |
| H. 650/701/760/1100/1200 18mm spline | DS#32 |
| I. GP1200R 20mm spline (18 tooth) | DS#56 |
| SHO/FZR/FZS 20 mm spline (20 tooth) | TOOL#53 |



DRIVE COUPLER TOOLS

Use to remove drive coupler from crankshaft and sub-shaft.

| Description | Part No. |
|------------------|----------|
| 650/701 | DS#60-3 |
| 760/800/110/1200 | DS#61-5 |



WATCON IMPELLER PITCH GAUGES

It's a known fact; not all impellers are created equal. Sometimes when impellers are mass produced, there are subtle differences that can affect performance. Use this simple tool to measure the pitch angle and blade length of each blade throughout its circumference. This enables you to make adjustments to the pitch where needed. Great for fine tuning, making minor changes or verifying pitch when sending impellers off for repair.

| Description | Part No. |
|---------------------|----------|
| 140-142mm Impeller | IMP-142 |
| 144-148mm Impellers | IMP-148 |
| 155-160mm Impellers | IMP-160 |



STUD TOOL

Economy stud installation and removal tool. The kit includes three sizes: 6mm, 8mm and 10mm.

| Description | Part No. |
|-----------------------|----------|
| Economy Stud Tool Kit | WJ7710 |



STUD INSTALLATION TOOLS

Will Install cylinder and intake manifold studs. Hex head is 3/4" or 19mm.

| Description | Part No. |
|-----------------------|----------|
| 6mm x 1.00 Stud Tool | 59-0212 |
| 8mm x 1.25 Stud Tool | 59-0213 |
| 10mm x 1.25 Stud Tool | 59-0214 |



HEX-PRO AND STAR-PRO PIVOT HEAD WRENCHES

- Pivot design allows for easy rotation around obstructions
- Heat treated alloy tool steel
- Includes heavy duty folding canvas storage pouch

| Description | Part No. |
|----------------|----------|
| Hex-Pro Metric | 08-0420 |
| Hex-Pro SAE | 08-0419 |
| Star-Pro | 08-0421 |

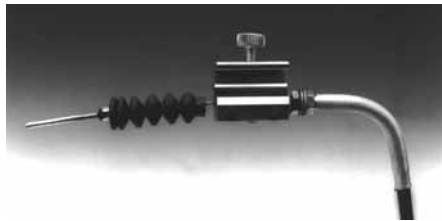

CABLE LUBBER

Installs quickly and helps free up corroded or tight cables. Note; Damaged cable should be replaced.

| Description | Part No. |
|--------------|----------|
| Cable Lubber | 59-0250 |



T-HANDLE RATCHET

Features a compact design that allows it to be used even in tight spaces.

| Description | Part No. |
|-----------------------|----------|
| 1/4" T-Handle Ratchet | 08-0231 |
| 3/8" T-Handle Ratchet | 08-0226 |



BALL END ALLEN SET

Made of chrome-vanadium tool steel. Size available 1.5, 2, 2.5, 3, 4, 5, 6, 8, & 10mm. Ball end allows for better access to allen-head bolts (up to 25 degree working angle.)

| Description | Part No. |
|--------------------|----------|
| Ball End Allen Set | 08-0185 |

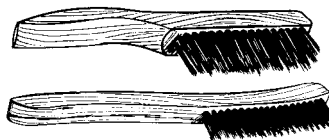

SCRATCH BRUSH

Removes rust, scale, paint, and solder from metal surfaces.

| Description | Part No. |
|---------------------------|----------|
| Shoe Handle Scratch Brush | LS14180 |
| Scratch Brush | LS14160 |



PARTS CLEANING BRUSH

| Description | Part No. |
|----------------------|----------|
| Parts Cleaning Brush | LS14000 |



MAGNETIC SOCKET HOLDERS

Standard and deep sockets fit on one convenient holder with powerful magnets, securely holding on to any steel surface. Red color only.

| Description | Part No. |
|----------------------------------|----------|
| 1/4" Holder with 26 compartments | LS40120 |
| 3/8" Holder with 28 compartments | LS40200 |

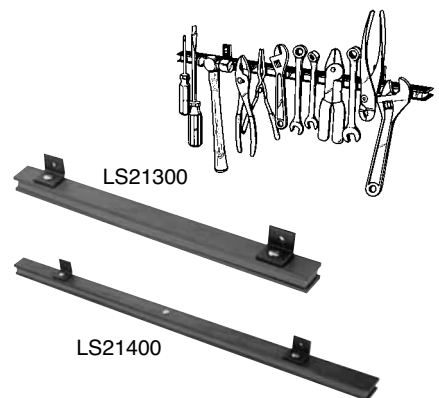

MAGNETIC TOOL HOLDERS

Powerful magnet holds even heavy hand tools. Ideal for both home and shop.

| Description | Part No. |
|-------------------------------|----------|
| 13" long Magnetic Tool Holder | LS21300 |
| 24" long Magnetic Tool Holder | LS21400 |

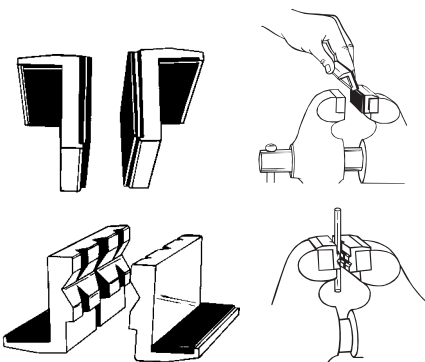

RUBBER-FACED & ALUMINUM VISE JAW PADS

These vise jaw pads are designed to protect delicate parts from damage. Sold in pairs.

| Description | Part No. |
|-------------------------------|----------|
| A. Rubber-faced Vise Jaw Pads | LS48100 |
| B. Aluminum Vise Jaw Pads | LS48000 |

FOUR
STROKE

INTAKE
SYSTEMS

ENGINE/
GASKETS

EXHAUST

DRIVE LINE
HANDLING

ELECTRICAL

WATERLINE
/BLIGE

STEERING
& CONTROLS

BODY

ACCESSORIES
SERVICE TOOLS

HARDWARE

CHEMICAL

FOUR
STROKEINTAKE
SYSTEMSENGINE/
GASKETS

EXHAUST

DRIVE LINE
HANDLING

ELECTRICAL

WATERLINE
/BILGESTEERING
& CONTROLS

BODY

SERVICE TOOLS
ACCESSORIESSERVICE TOOLS
/HARDWARE

CHEMICAL



RULE FLAT TANK ELECTRIC OIL EXTRACTOR

Eliminate those costly yard service fees with the new quick, clean, compact electric oil extractor. Includes a 3-1/2 gallon compact self-priming diaphragm pump for extraction and an easy pour spout for oil transfer.

- 3.5 gallon (13 liter) leak proof container
- Designed for ease of carrying
- Complete with dipstick, suction tube & battery

clamps

- Empties and stows easily
- Self-priming, dry running, 12 or 24 volt diaphragm pump

| Description | Part No. |
|------------------------|------------|
| Electric Oil Extractor | 17860-0012 |



HT MOTO 6 LITER OIL EXTRACTOR

The unit uses a small vacuum system, which pumps fluid through a hose to the 6-liter reservoir. It also includes a pour spout to aid in emptying the reservoir. Pump is removable for easy storage.

| Description | Part No. |
|-------------------------------|----------|
| HT Moto 6 Liter Oil Extractor | OIL01 |



HT MOTO 15 LITER OIL EXTRACTOR

Ideal for bigger jobs and shops, this larger capacity oil/fluid extractor makes changing the oil on your 4 stroke PWC, snowmobile, ATV, boat, lawn mower, etc. clean and hassle free. Holds up to 15 liters (3.92 gal) in this sturdy portable container with built in pump.

| Description | Part No. |
|--------------------------------|----------|
| HT Moto 15 Liter Oil Extractor | OIL03 |

FLUID EXTRACTOR

- Empties oil in 15 pumps or less
- Extracts warm or cold oil
- Pressure relief valve allows easy transportation and storage
- Single-hand-ease effortless operation
- Tethered cap
- Delivers gulp-free, mess-free performance
- Complete adapter kit is included featuring three extraction tubes

| Description | Part No. |
|---|----------|
| Fluid Extractor (6.5 Liter Fluid Extractor) | CJ-169-S |
| Fluid Extractor Tube Replacement Kit | MR08032 |

**Note: Not for use with gasoline.*



A3250

A3240

SHOP LANYARD

Not legal for riding.
For shop testing only.

| Description | Part No. |
|----------------------------|----------|
| KPTW, Yamaha, Sea Doo | A3240 |
| KPTW, Yamaha, Sea Doo DESS | A3250 |



4.5 GALLON DRAIN PANS

Now with built-in-ribs for draining filters in the pan. For easy transfer of liquids. High-density polyethylene material is resistant to chemicals and solvents, and is easy to clean. 1" wide diameter spout for quick and easy pouring. The anti-splash lip and baffles help prevent spilling when carrying or pouring. Comes with large, easy-grip handles. Two colors: 17942 is black for oil and 17952 is green for anti-freeze.

| Description | Part No. |
|---------------------------------|----------|
| 4.5 Gallon Oil Drain Pan, Black | LS17942 |
| 4.5 Gallon Oil Drain Pan, Green | LS17952 |



RATIO RITE CUP & LID

With Ratio Rite measuring cup get a perfect mix every time. Fill to the pre-calibrated ratio mark and pour into gas. Ratios are from 16:1 to 44:1 for up to 12 gallons. Calibrations also include oz., cc's, and pints.

| Description | Part No. |
|--------------------|----------|
| Ratio Cup | 59-0548 |
| Ratio Rite Cup Lid | 59-0582 |



**Adapter Kit
Included!**



ELME TOOLS SEVED PRO HARDWARE

Elme Tools has developed the newest essential tool for any PWC or Boat mechanic. Elme Tools utilized the newest state of the art technology to develop the "seved Pro" diagnostic tool.

The Seved Pro diagnostic unit is a multi manufacturer that will allow you to diagnosis, repair and perform the required maintenance of PWC and boats. This unit will boost your business by minimizing the diagnosis time and allowing you to perform more accurate and thorough maintenance or repair for your customers.

The Seved Pro is the only diagnostic tool you will need to purchase. Purchase the base unit and then purchase the modules for the specific manufacturer PWC's or boats as needed to man age your service department.

The Seved pro is also a key programming tool allowing you to offer this service to your customer without a trip to the PWC dealership.

Currently Elme Tools offers the following manufacturer modules:
 BOMBARDIER SEADOO 1998 - 2009
 YAMAHA PWC'S 2001 - 2009
 KAWASAKI JET SKIS 2001 - 2009
 HYDROSPACE/BENELLI
 MERCURY - MERCURISER ENGINES 2001 - 2009

- Portable and autonomous, it does not need to be plugged to any other machine
- No PC or power connector is needed.
- Key Programming
- Full Specialized technical support
- Updates via internet
- Cables and dongles are included
- Evolving device thanks to dongles system
- Free updates

Who is Elme Tools?

Elme Tools are the leader in car keys and controls programming. The companies first commercial activity has been focused on code keys and locks adaptation for all kind of vehicles. As time goes on the business philosophy had clearly gone towards a very specific expertise: the generic knowledge of everything related to active safety car system. Immobilizer, central locking (comfort), remote controls, transponders, activation of crypto keys, etc...

In sum, they have been developing diagnostic tools for the past 15 years and have sold so far 14,000 diagnostic devices in more than 100 countries. It is that experience that has allowed the company to expand into nautical sector. The companies policy is ambitious but simple, bring solutions to the market, manage it with efficiency and support it with the industries leading technical support.

| Description | Part No. |
|---|------------------|
| Seved Pro Hardware Base Unit | SEVED PRO |
| BRP Diagnostics Program | ADS400 |
| BRP Key Programming | ADS401 |
| Kawasaki Diagnostic Program | ADS402 |
| Mercuriser Diagnostic Program | ADS403 |
| Yamaha Diagnostic Program | ADS404 |
| Hydrospace/Benelli | ADS405 |
| Seved Pro Hardware Base Unit | PWCPACK |
| +ADS400+ADS401+ADS402+ADS404+ADS405 (excludes ADS403) | |
| Seved Pro Hardware Base Unit | FULLPACK |
| +ADS400+ADS401+ADS402+ADS403+ADS404+ADS405 | |

| | | | | | | | | | | |
|-------------|-----------------|---------|---------------------|------------|------------------|---------------------|------|-------------|-------------------------|----------|
| FOUR STROKE | ENGINE/ GASKETS | EXHAUST | DRIVE LINE HANDLING | ELECTRICAL | WATERLINE /BLIGE | STEERING & CONTROLS | BODY | ACCESSORIES | SERVICE TOOLS /HARDWARE | CHEMICAL |
|-------------|-----------------|---------|---------------------|------------|------------------|---------------------|------|-------------|-------------------------|----------|

